

REDFOOT

LEVELLING

FIAT Ducato Avida Birdsville/Leura 2024 Bracket Installation

Part Numbers AV-FID-HI-SL and AV-FID-LO-SL



Front bracket kit assembly:

1x RF-P-0022-03 Front Passenger side mounting bracket

1x RF-P-0026-04 Front Drivers side mounting bracket

2x RF-P-0023-02 Clamp Plate

2x Clamping Bar

2x Pivot T-Piece

4x M10 100mm Socket Head Screw bolts

4x M10 30mm bolts

4x M10 Spring washers

2x M10 Dual Rivsert Paddle Sticks

2x M10 25mm Countersunk Socket Head Screw bolts

4x M10 Nyloc Nuts and washers

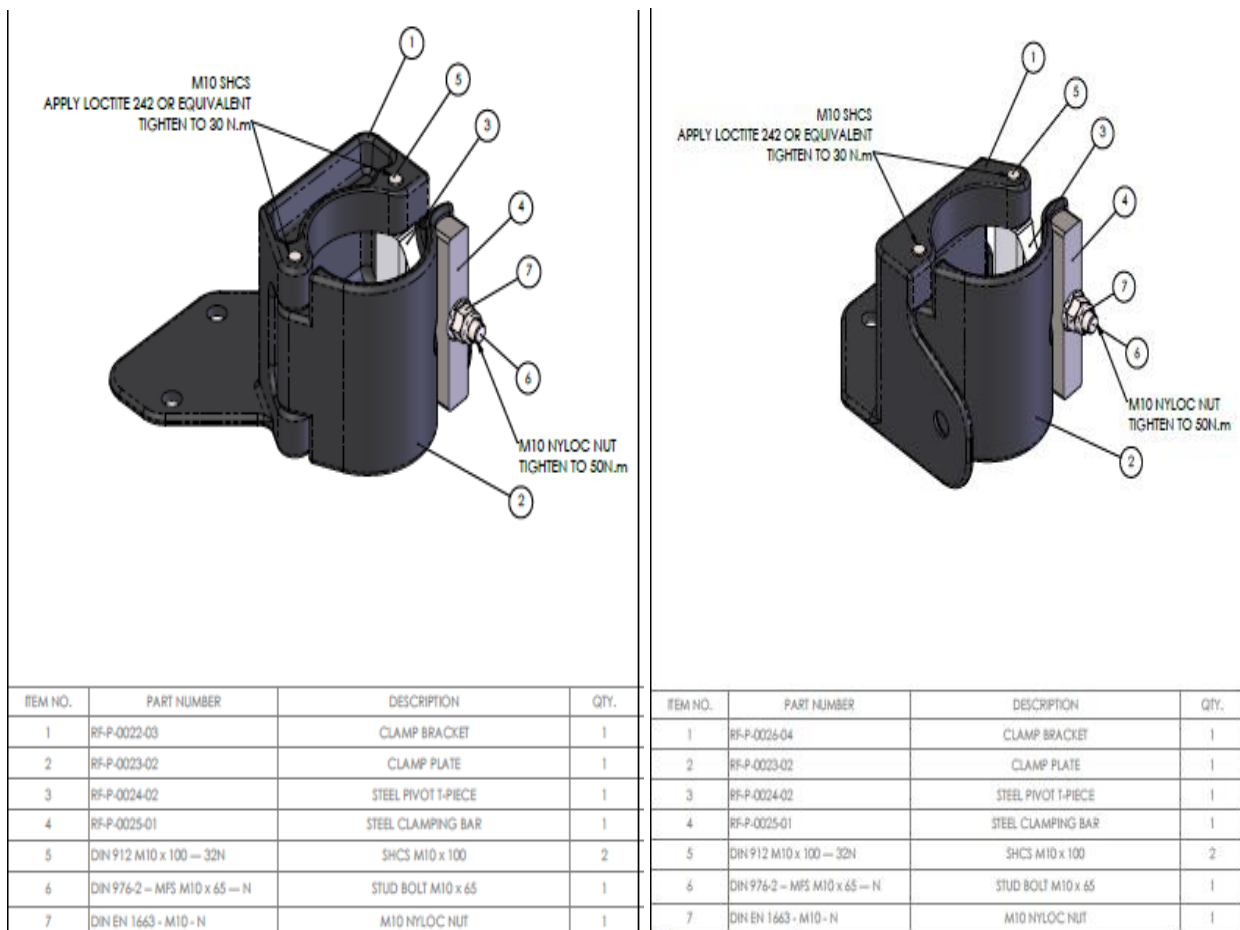

Rear bracket kit assembly:

4x Rear cylinder spacers

12x ½" x 3-1/2" bolts

12x ½" nyloc nuts

24x ½" Washers



Tools Required:

Power Drill (Ideally a Right Angle Drill)

Impact Wrench or Rattle Gun

10.5mm drill bit

13mm drill bit

Torque Wrench

16mm Socket and Spanner

18mm Socket and Spanner

¾" Socket and Spanner

1-1/16" Socket and Spanner

8mm Hex Socket head screw

6mm Allen key

***IMPORTANT! Each cylinder foot plate is to be mounted using the 3/4" locking nut supplied. A rattle gun or impact wrench must be used when tightening or loosening the locking nut.**

REDFOOT Front Passenger side location

Front passenger side mounting bracket assembly



MOUNTING BRACKET INSTRUCTIONS

1. The front passenger side bracket location is inside the chassis rail directly behind the passenger seat and between the vehicles battery box and fuel tank.
2. Firstly, clear away and reposition any existing looms and cables as shown.
3. With your bracket hold into position and mark with a paint pen the 3 holes for drilling both underneath and inside the chassis as shown.
4. **IMPORTANT!!** You will need to drill 3x 10.5mm holes.
5. Using a 10.5mm drill bit, drill the 3 hole as required. A small right angle drill will be advantages for drilling into these tight spacers.
6. Remove the square bung/plug located underneath the chassis. This will give you an access point into the chassis.
7. Insert the two holed Rivsert Paddle Stick into chassis plug hole as shown and align with the drilled two holes underneath the chassis rail. You will need to bend the handle as shown.
8. Hold the mounting bracket to the chassis and align holes, insert 2x M10 30mm bolts provided and lightly tighten. You will need to hold the paddle stick also, so will a second pair of hands would be required for this process.
9. Once in place insert the countersunk M10 25mm Socket Head Screw bolt into the side, place the M10 Nyloc nut and washer behind and tighten using a 6mm Allen key.

Front passenger side bracket mounting location

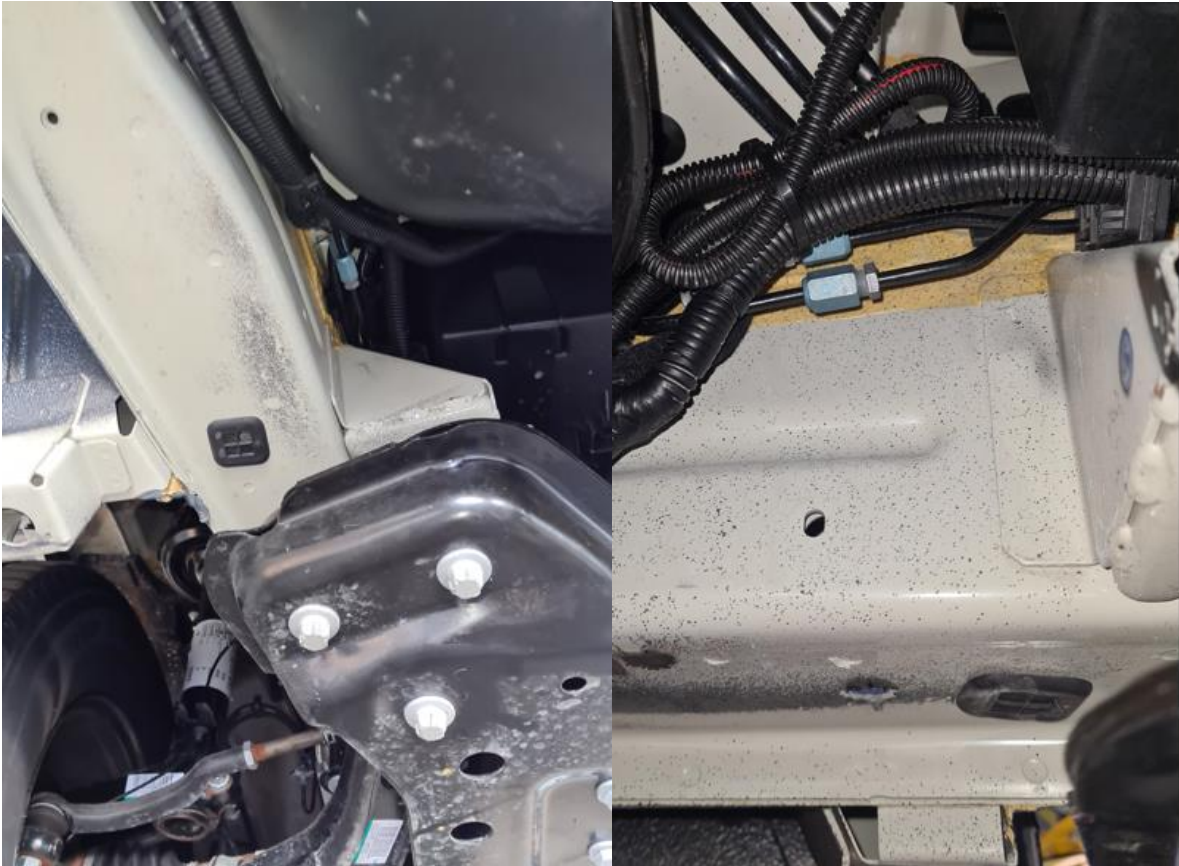

Mark the hole positions with paint pen



Drill through chassis as marked

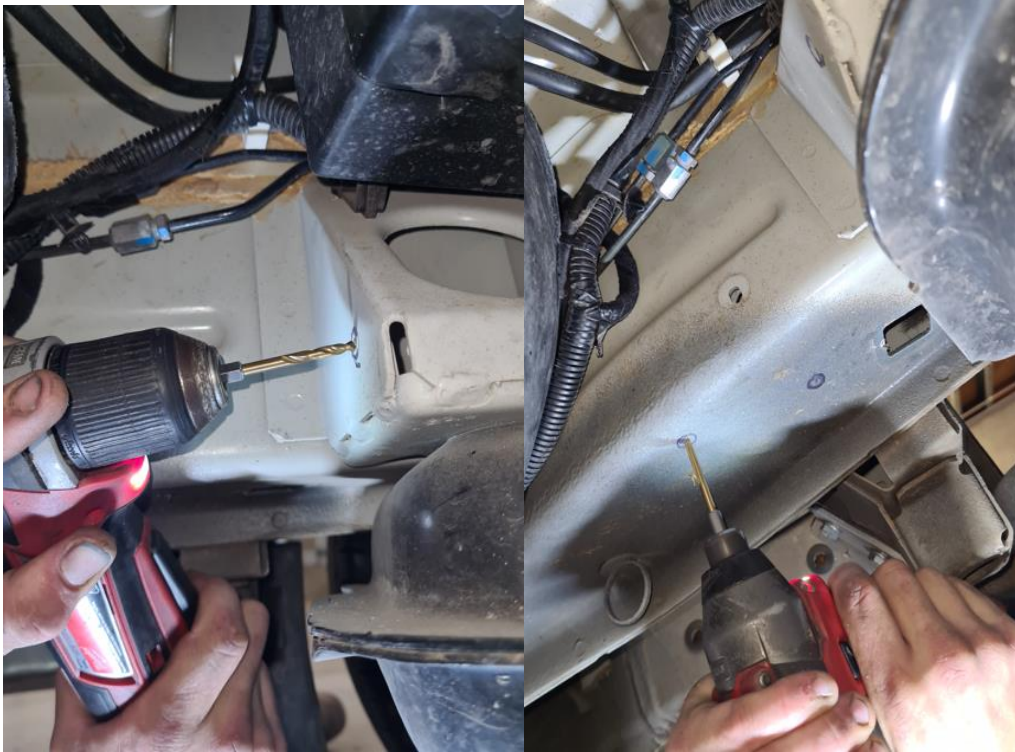

Insert Rivsert Paddle Stick inside chassis and position the bracket so the holes align. Hold the bracket into position and insert the two M10 30mm bolts into the underside of chassis, then tighten. Insert the countersunk M10 25mm Socket Head Screw bolt into the chassis side wall, ensure to use the M10 Nyloc Nut and washer, tighten using a 6mm Allen key.



MOUNTING HYDRUALIC CYLINDER INSTRUCTIONS

10. Once the bracket has been affixed to the chassis the cylinder can be place into position as shown. Use the Clamp Plate provided that wraps around the outer cylinder and align the hole both on the Clamp Plate and bracket. When this has been achieved insert the M10 100mm bolt and tighten. (use torque wrench to tighten at 30Nm)
11. The cylinder is now held freely in place and can be lifted or turned 360 degrees into the correct position prior to tightening the Clamp Plate. The optimal height from bottom of cylinder to ground in 200mm. Ensure you face the top port fitting towards the adjacent chassis rail as shown. This will allow easy fitment on hydraulic hose later.
12. Insert the Clamping Bar over the exposed Pivot T-Piece bolt on the bracket as shown and use the Nyloc nut to tighten loosely. Once you have the cylinder in the optimal position tighten the M10 Nyloc Nut at 50Nm using a torque wrench.
13. Once this has been achieved you can now install the foot plate to the underside of cylinder using the $\frac{3}{4}$ " locking nut provided.
14. **IMPORTANT!!** When tighten the foot plate to cylinder ensure to only use a rattle gun or impact wrench.

Tightened all bolts and position your cylinder



Hold the cylinder in place and use the Clamp Plate to align with the bracket holes, insert the M10 100mm Socket Head Screw bolt as shown.

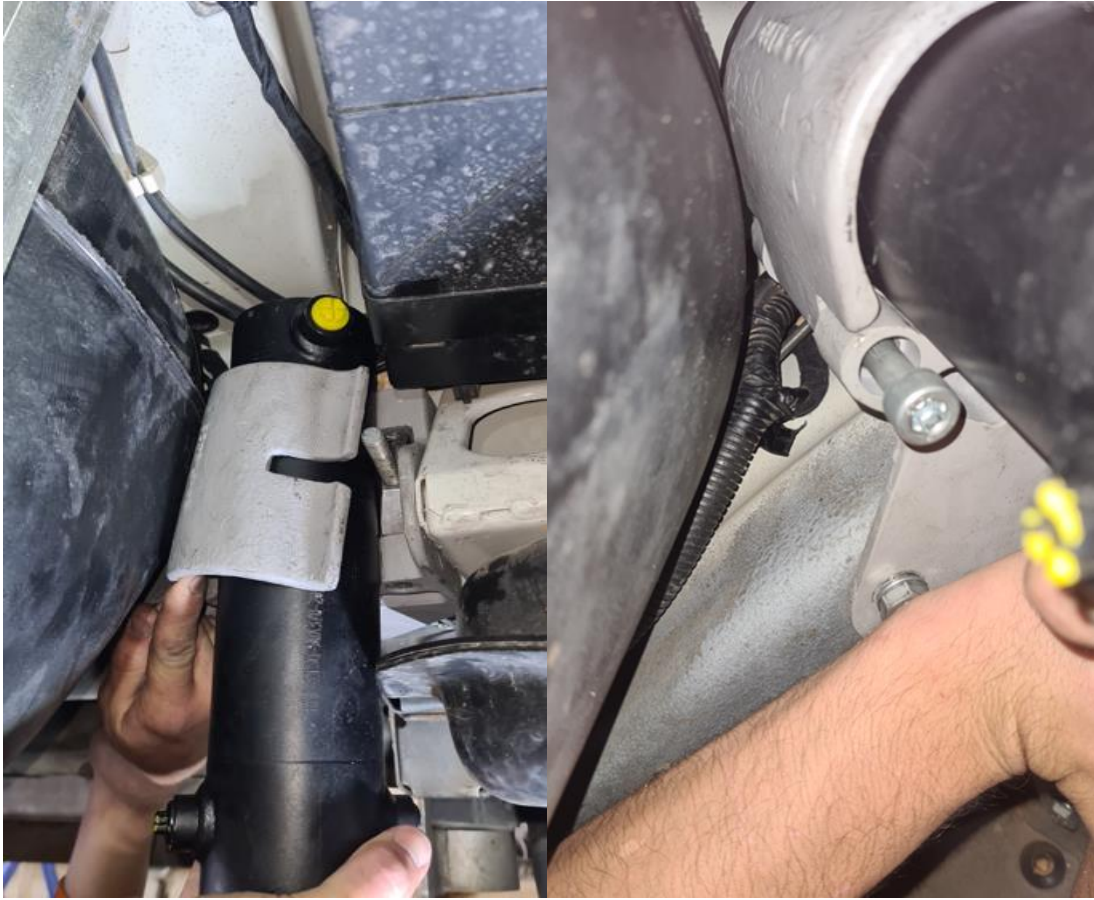

Tighten the M10 100mm Socket Head Screw bolt at 30Nm with Torque wrench.

This will hold cylinder loosely in place without dislodging. Place the Clamping Bar over the existing T-Piece Pivot bolt as shown and attach the M10 Nyloc nut.



Adjust the cylinder to correct height from the ground and tighten the M10 Nyloc nut to 50Nm



REDFOOT Front Driver side location

Front driver side mounting bracket assembly

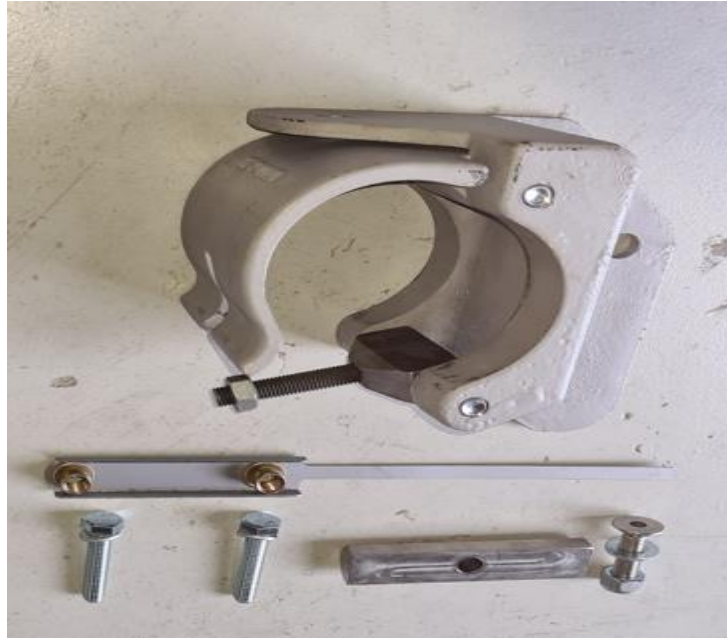

MOUNTING BRACKET INSTRUCTIONS

15. The front driver side bracket location is inside the chassis rail directly behind the underfloor of the driver seat and close to exhaust and catalytic converter.
16. Firstly, to clear this area on some vehicles you will be required to cut and remove some of the heat shield as shown.
17. With your bracket hold into position and mark with a paint pen the 3 holes for drilling both underneath and inside the chassis as shown.
18. IMPORTANT!! You will need to drill 3x 10.5mm holes.
19. Using a 10.5mm drill bit, drill the 3 hole as required. A small right angle drill will be advantages for drilling into these tight spacers.
20. Remove the square bung/plug located underneath the chassis. This will give you an access point into the chassis.
21. Insert the two holed Rivsert Paddle Stick into chassis plug hole as shown and align with the drilled two holes underneath the chassis rail. You will need to bend the handle as shown.
22. Hold the mounting bracket to the chassis and align holes, insert 2x M10 30mm bolts provided and lightly tighten. You will need to hold the Rivsert Paddle Stick also, so will a second pair of hands would be required for this process.
23. Once in place insert the countersunk M10 25mm Socket Head Screw bolt into the side, place the M10 Nyloc nut and washer behind and tighten using a 6mm Allen key.

Cut and remove heat shield if required



Mark the hole positions with paint pen



Drill through chassis as marked



Insert Rivsert Paddle Stick inside chassis and position the bracket so the holes align. Hold bracket into position and insert the 2x M10 30mm bolts into the underside of chassis, then tighten. Insert the countersunk M10 25mm hex head bolt into the chassis side wall,

ensure to use the washer/Nyloc Nut to tighten using a 6mm Allen key



MOUNTING HYDRUALIC CYLINDER INSTRUCTIONS

24. Once the bracket has been affixed to the chassis the cylinder can be placed into position as shown.
25. The cylinder can now be lifted or turned 360 degrees into the correct position prior to tightening the Clamp Plate. The optimal height from bottom of cylinder to ground in 200mm. Ensure you face the top port fitting towards the rear of vehicle or parallel to the chassis rail as shown. This will allow easy fitment on hydraulic hose later.
26. Now insert the Clamping Bar over the exposed Pivot T-Piece bolt on the bracket as shown and use the Nyloc Nut to tighten loosely. Once you have the cylinder in the optimal position tighten the M10 Nyloc Nut at 50Nm using a torque wrench.
27. Once this has been achieved you can now install the foot plate to the underside of cylinder using the 1-1/16" locking nut provided.
28. **IMPORTANT!!** When tighten the foot plate to cylinder ensure to only use a rattle gun or impact wrench.

Tightened all bolts and position your cylinder



Place the Clamping Bar over the existing pivot bolt as shown and attach the M10 Nyloc nut.



Adjust the cylinder to correct height from the ground and tighten Nyloc nut at 50Nm using a Torque Wrench



Rear bracket kit assembly:

12x ½" x 3-1/2" bolts

12x ½" Nyloc Nuts

24x ½" Washers

4x Cylinder Spacers

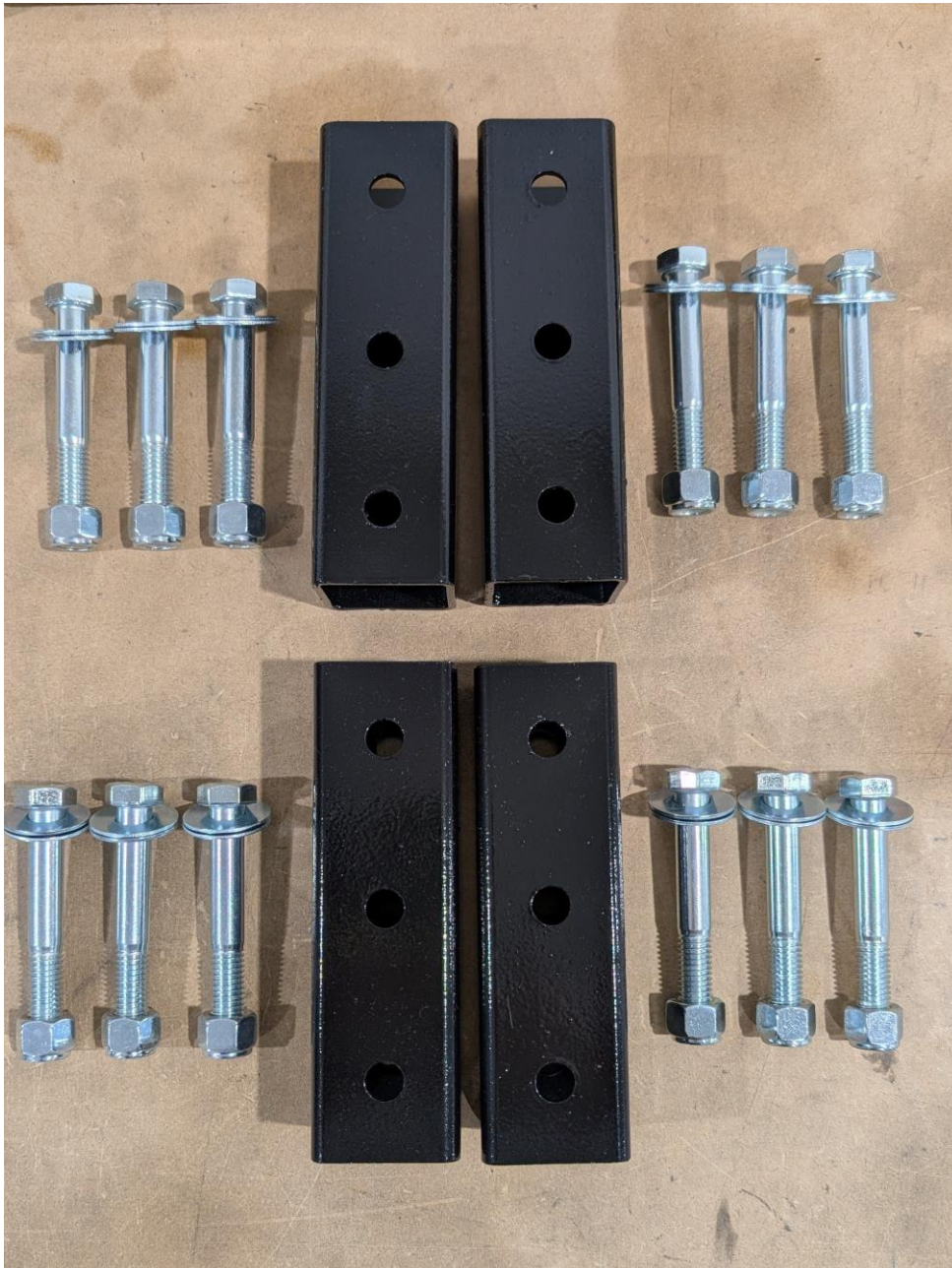

REDFOOT Rear bracket locations

1. The location for the rear left passenger side and right driver side brackets is directly behind the axle, in line with the leaf spring hangers.
2. Drill through the chassis in the location provided in the photos.
3. Set the height of the cylinders to 200mm from floor to bottom of foot plate.
4. Torque 6 bolts on each cylinder to 77nm.
5. Once this has been achieved you can now install the foot plate to the underside of cylinder using the 1-1/16" locking nut.
6. IMPORTANT!! When tighten the foot plate to cylinder ensure to only use a rattle gun or impact wrench.



Rear bracket locations



Bolt through the chassis



Affixing Cylinders to the brackets
Cylinder bolts must be torqued to 77Nm (57lb-ft).

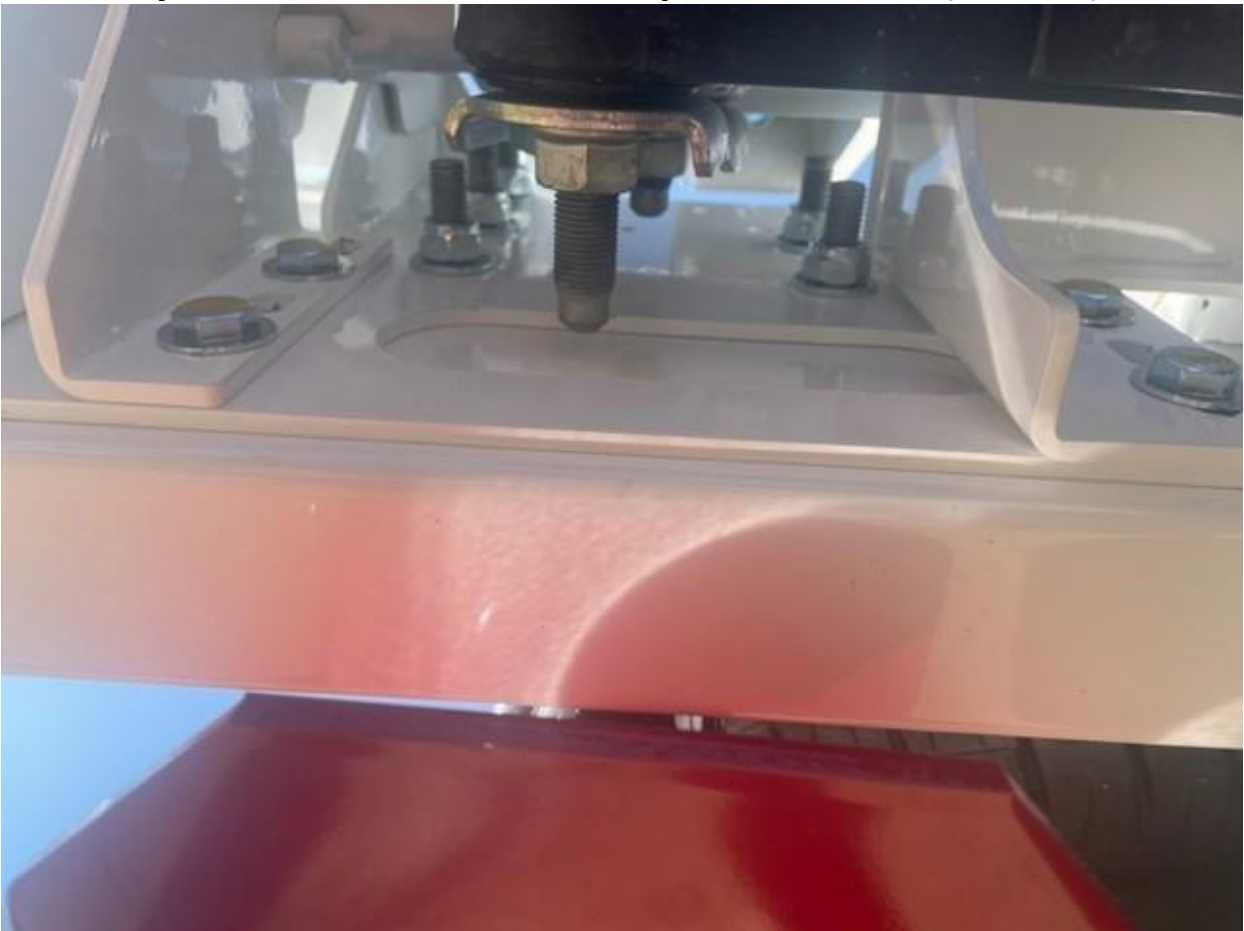

Ready for deployment



REDFOOT Keypad Recommendation



The ideal location for the keypad is near the entrance inside the vehicle. For ease of use, mount the keypad on the side as you enter the motorhome so when you are facing the keypad you are facing forward in the vehicle. (Like you are driving the vehicle)

This position will allow you to operate from either inside or outside the vehicle. Allow enough space behind the keypad panel to give good access to harness connection plugs.

You will require a Cutting Router to cut a hole in the wall and Power Drill to screw and affix the keypad to the wall.

REDFOOT Pump/Manifold Locations



The ideal location for the Pump/Manifold can be inside E.g Storage compartment or outside the vehicle as shown. The important thing is to have ease of access in the case of a 'manual override' to retract all cylinders. This can only happen if you lose all power to the system and you need to move on from your site.

There are two access points you need in a manual override situation; access to front of motor and access to the four valves on the side of pump. See the picture directly above with the arrows pointing to these. For more information on this process read the manual override section in your user manual.

If you decide to install the Pump/Manifold to the underneath of the vehicle please ensure you install a protection cover to prevent objects hitting the unit or reservoir, potentially damaging the system.

REDFOOT Operational



For further information contact:
Redfoot Levelling Pty Ltd
Unit 1, 7 Abeles Street
Baringa QLD 455126-34
Ph 07 5228 0211
www.redfootlevelling.com.au